

LED 2025/2026

RECESS/SURFACE MOUNTED LIGHT, MODULAR

0% 100%



Water Tolerant



- > *CRI 90 lights are Title 24 Compliant
 - > *CRI 90 lights offer more vibrant, true color rendering than lower CRI products
 - > Compatible with Loox and E-series drivers only
 - > Degree of Protection: IP44 recess mounted
IP20 surface mounted
- Note**
Trim rings and leads sold separately.

LED 2025				LED 2026				80°	
2700 K	3000 K	4000 K	5000 K	2700 K	3000 K	4000 K	5000 K		
2600 lx	2650 lx	2700 lx	2800 lx	1400 lx	1800 lx	1850 lx	1950 lx	250 mm (9 13/16")	
730 lx	750 lx	780 lx	800 lx	400 lx	500 lx	520 lx	550 lx	500 mm (19 11/16")	
320 lx	350 lx	345 lx	350 lx	175 lx	225 lx	235 lx	250 lx	750 mm (29 1/2")	
180 lx	185 lx	185 lx	190 lx	100 lx	125 lx	135 lx	140 lx	1000 mm (39 3/8")	

	LED 2025				LED 2026			
Item No.	833.72.350	833.72.351	833.72.352	833.72.323	833.72.360	833.72.361	833.72.362	833.72.137
SRP	\$40.00	\$40.00	\$40.00	\$40.00	\$40.00	\$40.00	\$40.00	\$40.00
Light Color (K)	2700 warm white	3000 warm white	4000 cool white	5000 cool white	2700 warm white	3000 warm white	4000 cool white	5000 cool white
Drill hole	Ø58 mm (2 1/4")							
Ø x H	61.2 x 13.5 mm (2 7/16" x 17/32")							
Wattage	3.8				3.0			
LEDs	1 (COB) - chip on board				6			
Lumen	270	300	306	345	185	210	221	260
Lumen per watt	71	78	80	90	62	70	74	87
CRI	90*			83	90*			83
Energy Efficiency class	A+							
Weighted energy consumption	4.18				3.30			
Material	Aluminum							
Note	Loox Lights and Drivers are "Suitable for use within Closet Storage Spaces"							

LED 2025/2026

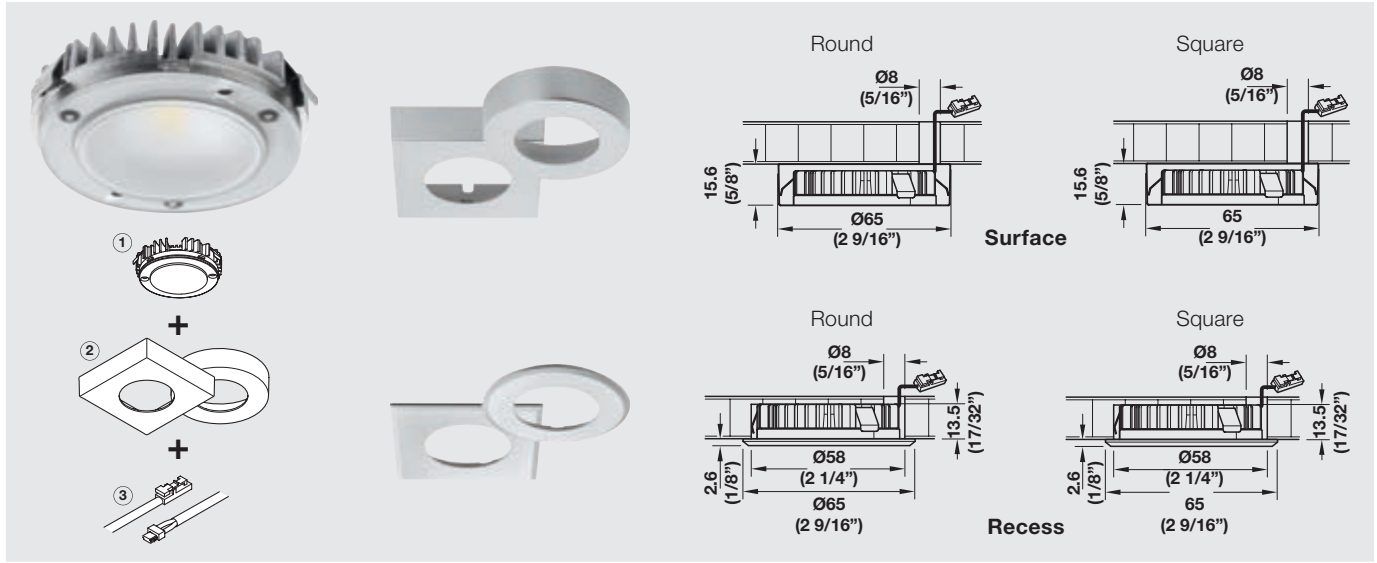

- > Dimmable
- > For mounting in drilled hole with clip fastener or screw mounting



- > Driver see page 51
- > Drill bit see page 146

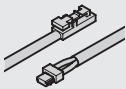

- Lead with snap-in connector
Plastic, black
500 mm (19 11/16")
- > Item No. 833.72.880 **SRP \$4.00**
1000 mm (39 3/8")
 - > Item No. 833.72.881 **SRP \$4.00**
2000 mm (78 3/4")
 - > Item No. 833.72.882 **SRP \$6.00**



Surface mounted trim ring, Plastic

SRP	\$3.00	\$3.00
Finish	Round	Square
silver colored	833.72.124	833.72.125
black	833.72.160	833.72.164
nickel matt	833.72.162	833.72.166
white	833.72.163	833.72.167
anthracite	833.72.193	833.72.195
bronze brown	833.72.192	833.72.196
stainless steel color	833.72.194	833.72.197

Note

IP20 Protection with surface mounted trim ring.

Recess mounted trim ring, Plastic

SRP	\$3.00	\$3.00
Finish	Round	Square
silver colored	833.72.126	833.72.127
black	833.72.168	833.72.172
nickel matt	833.72.170	833.72.174
white	833.72.171	833.72.175
anthracite	833.72.380	833.72.383
bronze brown	833.72.381	833.72.384
stainless steel color	833.72.382	833.72.385



LOOX LED DRIVER

CONSTANT VOLTAGE 12 V

12 V SYSTEM

THIN PROFILE

- 1 Item No. 833.74.960
 $\otimes_1 + \otimes_2 + \dots + \otimes_6 < 20 \text{ W}$
- 2 Item No. 833.74.962
 $\otimes_1 + \otimes_2 + \dots + \otimes_6 < 40 \text{ W}$
- 3 Item No. 833.74.964
 $\otimes_1 + \otimes_2 + \dots + \otimes_6 < 60 \text{ W}$
max. 42 W per light output

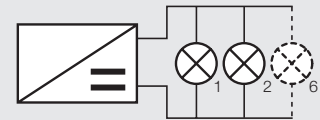

Parallel connection



- > Suitable for all of the world's power systems
- > With an integrated port for a wide selection of switches
- > Max. 42 W per light output
- > Lead length from driver to switch: Max.: 6 m (236 1/4")



- > Class 2
- > Efficiency Level VI
- > Degree of protection : IP20
- > LoOX drivers cannot be controlled by a dimmer wall switch

Item No.	833.74.960 1	833.74.962 2	833.74.964 3
SRP	\$36.00	\$60.00	\$80.00
L x W	140 x 50 x 16 (5 1/2" x 2" x 5/8")	190 x 60 x 16 (7 1/2" x 2 3/8" x 5/8")	230 x 70 x 16 (9 1/16" x 2 3/4" x 5/8")
Wattage	0 – 20	0 – 40	0 – 60
Standby Power Consumption Wattage	<0.1	<0.1	<0.2
Input voltage	100 – 240 V~; 50 – 60 Hz		
Output voltage	12 V DC		
Output current	1.67 A	3.33 A	5.0 A
Number of slots	6 for lights, 1 for switch, 1 for power cord		
Material/Finish	Plastic, black		
Supplied with	Mounting accessories, US power cord		
Note	LoOX Lights and Drivers are "Suitable for use within Closet Storage Spaces"		



- > Switches see pages 113 - 116
- > Extension leads see page 127



- Power cord with 90° plug
2 m (78 3/4")
- > Item No. 833.89.017 **SRP \$5.00**



- 90° Plug adapter
- > Item No. 833.89.018 **SRP \$7.00**

Country-specific 2 m (78 3/4") primary leads								3 m (118")
Item No.	833.89.000	833.89.001	833.89.002	833.89.003	833.89.016	833.89.005	833.89.050	833.89.008
SRP	\$10.00	\$4.00	\$4.00	\$4.00	\$4.00	\$4.00	\$4.00	\$6.00
Plug design								
Designation	UK	AU	EU	US	JP	CN	US	US
Voltage (V)	250	250	250	120	100	250	120	120

LED DRIVER

CONSTANT VOLTAGE PLUG-IN DRIVER

12 V SYSTEM

-  > Degree of protection: IP20
- > 4 m (157 1/2") lead
- > Class 2



Item No.	833.74.934	833.74.936	833.74.938
SRP	\$12.00	\$20.00	\$30.00
L x W x H	61 x 37 x 43 (2 3/8" x 1 1/2" x 1 11/16")	78 x 46 x 54 (3 1/16" x 1 13/16" x 2 1/8")	84 x 50 x 58 (3 5/16" x 2" x 2 5/16")
Stand-by Power Consumption	0.3 W		
Input voltage	100-240 V; 50-60 Hz		
Output voltage	12 VDC		
Output current	6	15	27
Degree of protection	IP 20		
Number of slots	1 socket for lead		
Material/Finish	Plastic, black		

Note
Loox Lights and Drivers are "Suitable for use within Closet Storage Spaces"



Secondary lead 12 V, Plastic, black with 2 connections

- > 4 m (157 1/2") Item No. 833.74.749 **SRP \$8.00**
- > 2 m (78 3/4") Item No. 833.74.791 **SRP \$8.00**

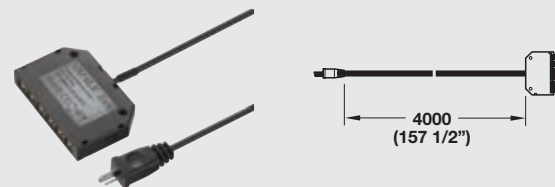

Secondary lead 12 V, Plastic, black with 6-way distributor, 4 m (157 1/2")

- > Item No. 833.74.748 **SRP \$12.00**

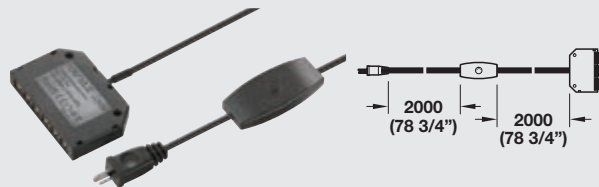

Secondary lead 12 V, Plastic, black with dimmer and 6-way distributor

- > Item No. 833.74.709 **SRP \$30.00**

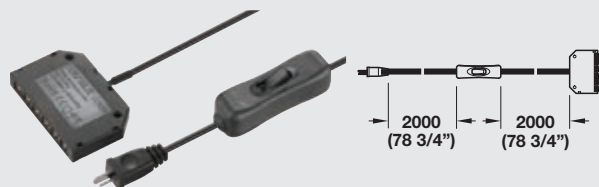

Secondary lead 12 V, Plastic, black with rocker switch and 6-way distributor

- > Item No. 833.74.746 **SRP \$24.00**